

Multipoint Mortice locks



Summary

5000 Trilock.....	2
-------------------	---

A full range ranking from stan- dard to ultimate security levels

The multipoints locks of the 5000 range are designed first and foremost for entrance doors. As mortice solutions they preserve the door's aesthetics and, above all, provide security at every level of the A2P labels: A2P*, A2P** and A2P***.

All the locks of the 5000 range can be supplied with a door retainer device.

ADVICE

Follow the fitting instructions and templates scrupulously. Clean the mortices carefully prior to fitting the lock inside the door.

After fitting: Test the lock functions with the door open. To ensure warranty do not alter the product's characteristics.

Do not paint over the front plate.

⁽¹⁾ FOR A2P LABELLED PRODUCT :
A2P labelled product must be installed with all accessories listed in our catalogue. The A2P certification applies only for products installed as a set as described in the following pages.



Applications

Types of applications

These locks are ideal for entrance doors and all doors requiring reinforced security [kite marked products]. They are suitable for timber and metal doors.



Technical datas

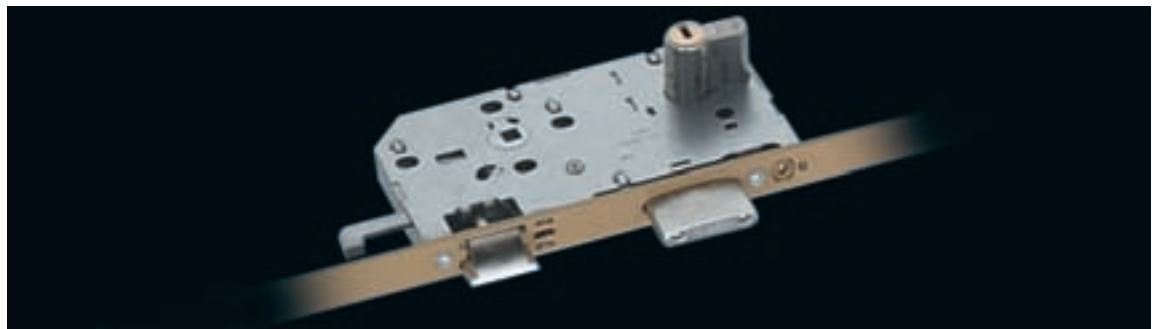

- Central lock case: 148 x 78 x 15 mm, galvanised steel
- Frontplate: 3 mm thick steel, epoxy finish [bronze 39]
- Rods: galvanised steel
- Follower: spindle 8 and 7 mm
- Backset: 50, 60 or 65 mm (according to lock version)
- Distance: 72 and 70 mm
- Detailed dimensions and technical drawing on www.vachette.fr
- Bolts: profiled dead bolt, curved latch bolt
- Models:
 - 5 locking points: round bolts [for 5700 models and 5900 models]
 - 3 locking points: rectangular bolts [for 5000 models]
- Option: Flat or angle strike plate
- Operation: latch bolt operated by lever handle or key. Dead bolts operated by key.

Special features



SÉCURITÉ

- Profiled dead bolt for greater side resistance
- Curved latch bolt: Double function originally designed by Vachette with noise reduction and follow-through effect when closing the door.
- CFPF fire-rated lock / hour
- Reversible without dismantling the lock out of the door
- Optional: integrated door retainer
- For Europrofile cylinder with DIN cam
- 10 year warranty NF QC CFPF





A2P*** (1)

with LAURA armoured trims



QC NF P26-103



Ultra-high security lock, 50 mm backset, 3 lateral dead bolts, reversible latch bolt. With LAURA armoured door plate

Ref. 5000 ET3/EF3 T170

Frontplate 1700 x 18 mm

Painted, with rounded corners, 3 rectangular dead bolts, without strike plate, suitable for pull handle (ET3) or lever handle (EF3)

Packaging: units of 5

The lock must be fitted with LAURA trims, its strike plates, its Radial cylinder NT + N3 and its protector (to be ordered separately).

Obligatory cylinders

RADIAL NT+ N3

Ref. 7101 NT+ N3, Nickel

Ref. 7100 NT+ N3, Brass

Ref. 5000 ET3/EF3 T204

Frontplate 2040 x 18 mm

Painted, with square corners, 3 rectangular dead bolts, without strike plate, suitable for pull handle (ET3) or lever handle (EF3)

Packaging: units of 5

The lock must be fitted with LAURA trims its strike plates, its Radial cylinder NT + N3 and its protector (to be ordered separately).

Obligatory cylinders

RADIAL NT+ N3

Ref. 7101 NT+ N3, Nickel

Ref. 7100 NT+ N3, Brass

LAURA armoured trims

Ref. E 3545 / PE 3545

For lock references 5000 ET3/EF3 T170 and 5000 ET3/EF3 T204. A2P*** for Europrofile cylinder with protector, lever handle function, solid aluminium, anodised Silver or Champagne finishes. For door thickness from 39 to 50 mm*: ref. E 3545 - for door thickness 51 to 60 mm*: ref. PE 3545.

If the lock is not centred within the door thickness, look up the protector dimension in the chart. Packaging: units of 1.

Ref. E 3546 / PE 3546

For lock references 5000 ET3/EF3 T170 and 5000 ET3/EF3 T204. A2P*** for Europrofile cylinder with protector, pull handle function, solid aluminium, anodised Silver or Champagne finishes. For door thickness from 39 to 50 mm*: ref. E 3546 - for door thickness 51 to 60 mm*: ref. PE 3546.

If the lock is not centred within the door thickness, look up the protector dimension in the chart below. Packaging: units of 1.

(1) FOR A2P LABELLED PRODUCT :

A2P labelled product must be installed with all accessories listed in our catalogue. The A2P certification applies only for products installed as a set as described in the following pages.

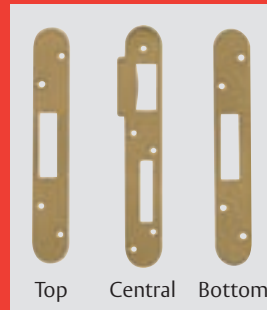
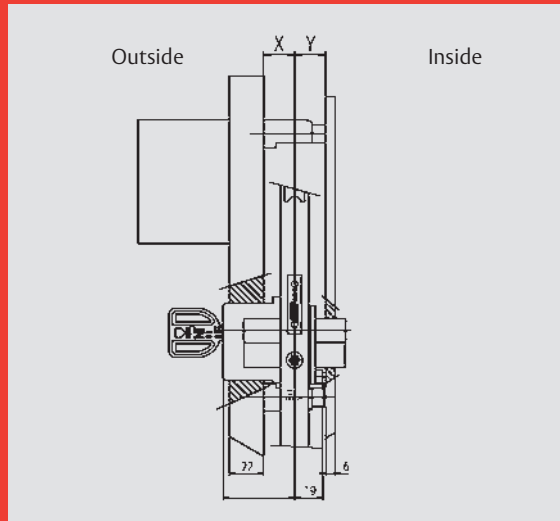

Strike plates for 5000 A2P* (1)**

Set of flat reinforced strike plates

Ref. 300 R

- Rounded corners
- 1 central strike plate
- 2 top and bottom strike plates
- Reversible
- Yellow galvanised
- Packaging: units of 10
- Dimensions :
Central 175 x 28 x 5 mm
(width including lip 34)
top and bottom
175 x 28 x 5 mm

Protectors for 5000 A2P* (1) with LAURA armoured trims**

Ref. M5

How to choose cylinder

Y	PROTECTEUR A
	Dimension Y cylinders for X from 20 to 25 mm
19 à 25 mm	32,5 x 32,5
26 à 30 mm	32,5 x 37,5
31 à 35 mm	32,5 x 42,5

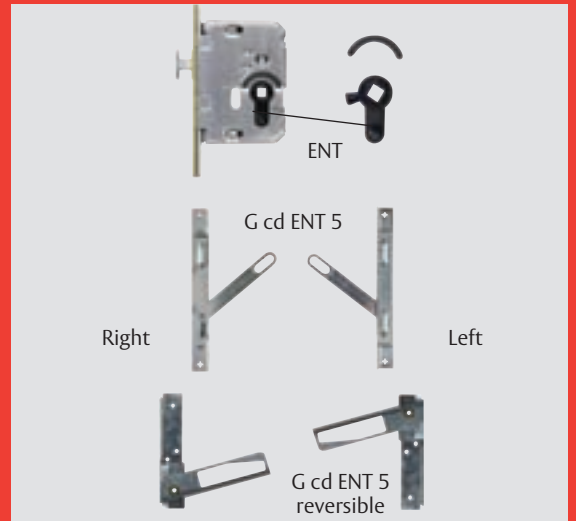

Accessories and supplements for 5000 A2P* (1)**

Optional door retainer [please specify when ordering]

Ref. ENT

- Add ENT before the commercial lock reference
- Without strike plate

Strike plates for door retainer

Ref. G ENT 5

- For rebated doors
- Square corners (K) for metal door frames in white galvanised finish, or rounded corners (R) for timber door frames in yellow galvanised finish (to be specified when ordering)
- Non-reversible (right hand or left hand to be specified when ordering)
- Packaging: units of 10
- Dimensions : 230 x 25 x 15 mm

Ref. G cd ENT 5

- For flush doors
- Reversible
- Yellow galvanised for timber door frames or white galvanised for metal door frames
- Packaging: units of 10
- Dimensions : 138 x 30 x 15 mm



A2P** (1)

Lock to be used with handle on plates or roses adapted for cylinder protector



High security lock, 50 mm backset, 3 lateral dead bolts

Ref. 5000 SGN2 T204



Frontplate 2040 x 18 mm, painted, with square corners, without strike plate, without cylinder, without protector (to be ordered separately),

3 rectangular dead bolts

Packaging: units of 5

Allows the use of any type of trims adapted to the shape of the protector

Obligatory cylinders

RADIAL NT+ N2

Ref. 7101 NT+ N2, Nickel

Ref. 7100 NT+ N2, Brass

(1) FOR A2P LABELLED PRODUCT :

A2P labelled product must be installed with all accessories listed in our catalogue. The A2P certification applies only for products installed as a set as described in the following pages.



High security lock, 50 mm backset, 5 lateral dead bolts This lock is particularly suitable for restored doors with existing metal frames

Ref. 5700 SGN2 T204

Frontplate 2040 x 18 mm, painted, with square corners, without strike plate, without cylinder, without protector (to be ordered separately),

1 rectangular central dead bolt, 2 x 2 freely rotating, anti-saw rounded dead bolts set 20 mm apart

Packaging: units of 5

Allows the use of any type of trims adapted to the shape of the protector

Obligatory cylinders

RADIAL NT+ N2

Ref. 7101 NT+ N2, Nickel

Ref. 7100 NT+ N2, Brass

High security lock, 50 mm backset, 5 lateral dead bolts

Ref. 5900 SGN2 T204



Frontplate 2040 x 18 mm, painted, with square corners, without strike plate, without cylinder, without protector (to be ordered separately),

1 rectangular central dead bolt, 4 freely rotating, anti-saw rounded dead bolts set 100 mm apart

Packaging: units of 5

Allows the use of any type of door plate adapted to the shape of the protector

Obligatory cylinders

RADIAL NT+ N2

Ref. 7101 NT+ N2, Nickel

Ref. 7100 NT+ N2, Brass

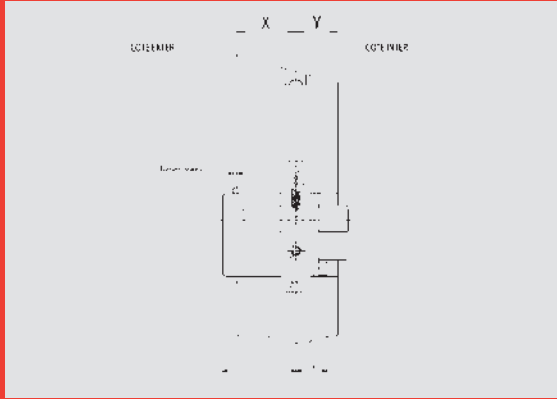

Protectors for 5000 A2P**

Ref. M5

	PROTECTOR A	PROTECTOR C
Y	X	X
	20 à 39 mm	40 à 49 mm
19 à 25 mm	32,5 x 32,5	42,5 x 32,5
26 à 30 mm	32,5 x 37,5	42,5 x 37,5
31 à 35 mm	32,5 x 42,5	42,5 x 42,5



108 R

Strike plates for 5000 A2P**

Set of flat reinforced strike plates

Ref. 108 R

- Rounded corners
 - 1 central strike plate
 - 2 top and bottom strike plates
 - Reversible
 - Yellow galvanised
 - Central, top and bottom strike plates with rectangular cut-outs
 - Packaging: units of 10
- Dimensions : Central 175 x 20 x 5 mm (width including lip 32)
top and bottom 175 x 20 x 5 mm



107 R

Strike plates for 5700 A2P**

Set of flat reinforced strike plates

Ref. 107 R

- Rounded corners
 - 1 central strike plate
 - 2 top and bottom strike plates
 - Reversible
 - Yellow galvanised
 - Central strike plate with rectangular cut-out
 - Top and bottom strike plate with round cut outs set 20 mm apart
 - Packaging: units of 10
- Dimensions : Central 175 x 20 x 5 mm (width including lip 32)
top and bottom 175 x 20 x 5 mm

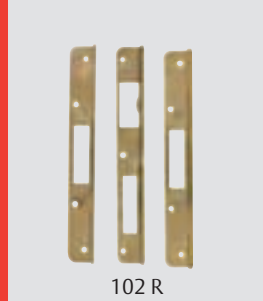

102 R

Set of reinforced angle strike plates

Ref. 102 R

- Rounded corners
 - 1 central strike plate
 - 2 top and bottom strike plates
 - Non-reversible (please specify right or left hand)
 - Yellow galvanised
 - Central, top and bottom strike plates with rectangular cut-outs
 - Packaging: units of 10
- Dimensions : Central 170 x 20 x 20 x 4 x 2 mm
top and bottom 170 x 20 x 20 x 4 x 2 mm

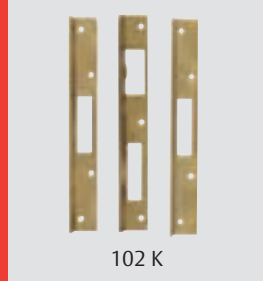

102 K

Ref. 102 K

- Square corners
 - 1 central strike plate
 - 2 top and bottom strike plates
 - Non-reversible (please specify right or left hand)
 - Yellow galvanised
 - Central, top and bottom strike plates with rectangular cut-outs
 - Packaging: units of 10
- Dimensions : Central 170 x 20 x 20 x 4 x 2 mm
top and bottom 170 x 20 x 20 x 4 x 2 mm

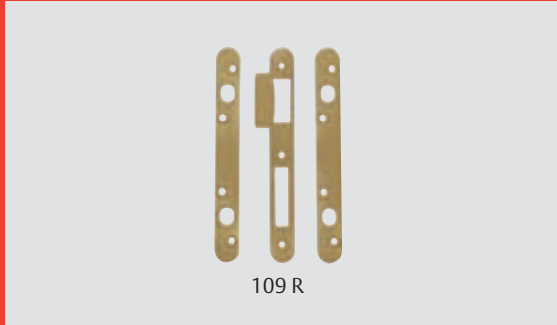

109 R

Strike plates for 5900 A2P**

Set of flat reinforced strike plates

Ref. 109 R

- Rounded corners
 - 1 central strike plate
 - 2 top and bottom strike plates
 - Reversible
 - Yellow galvanized
 - Central strike plate with rectangular cut-out
 - Top and bottom strike plate with round cut-outs set 100 mm apart
 - Packaging: units of 10
- Dimensions : Central 175 x 20 x 5 mm (width including lip 32)
top and bottom 175 x 20 x 5 mm

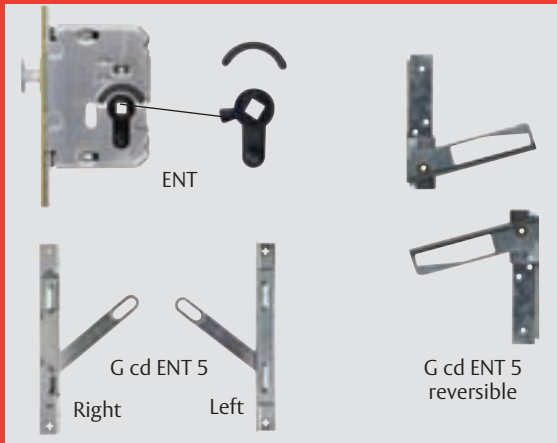

Accessories and supplements for 5000 A2P**

Optional door retainer [please specify when ordering the lock]

Ref. ENT

- For models 5000, 5700 and 5900
- Add ENT before the commercial lock reference
- Without strike plate

Strike plate for door retainer

Ref. G ENT 5

- For rebated doors
 - Square corners (K) for metal door frames in white galvanized finish, or rounded corners (R) for timber door frames in yellow galvanized finish (to be specified when ordering)
 - Non-reversible (right hand or left hand to be specified when ordering)
 - Packaging: units of 10
- Dimensions : 230 x 25 x 15 mm

Ref. G cd ENT 5

- For flush doors
 - Reversible
 - Yellow galvanized for timber door frames or white galvanized for metal door frames
 - Packaging : units of 10
- Dimensions : 138 x 30 x 15 mm



A2P^{*(1)}

Lock to be used with handle on plates or roses adapted for cylinder protector



Security lock, 50 mm backset, 3 lateral dead bolts

Ref. 5000 SPN1 T204



Frontplate 2040 x 18 mm, painted, with square corners, 1 rectangular central dead bolt, 2 rectangular dead bolts

Packaging: units of 5

- Obligatory cylinders
- RADIAL NT+ N1
- Ref. 7101 NT+ N1, Nickel
- Ref. 7100 NT+ N1, Brass
- Or
- VIP N1
- Ref. 7101 VIP N1, Nickel

Security lock, 50 mm backset, 5 lateral dead bolts

Ref. 5700 SPN1 T204

Frontplate 2040 x 18 mm, painted, with square corners, 1 rectangular central dead bolt, 2 x 2 freely rotating, anti-saw rounded dead bolts set 20 mm apart

Packaging: units of 5

- Obligatory cylinders
- RADIAL NT+ N1
- Ref. 7101 NT+ N1, Nickel
- Ref. 7100 NT+ N1, Brass
- Or
- VIP N1
- Ref. 7101 VIP N1, Nickel

Ref. 5900 SPN1 T204



Frontplate 2040 x 18 mm, painted, with square corners, 1 rectangular central dead bolt, 4 freely rotating, anti-saw rounded dead bolts set 100 mm apart

Packaging: units of 5

- Obligatory cylinders
- RADIAL NT+ N1
- Ref. 7101 NT+ N1, Nickel
- Ref. 7100 NT+ N1, Brass
- Or
- VIP N1
- Ref. 7101 VIP N1, Nickel

⁽¹⁾ FOR A2P LABELLED PRODUCT :
A2P labelled product must be installed with all accessories listed in our catalogue. The A2P certification applies only for products installed as a set as described in the following pages.



100 OBLONG R



100 OBLONG K



103 OBLONG R



102 R



102 K

Strike plates for 5000 A2P*

Set of flat strike plates

Ref. 100 OBLONG R

- Rounded corners
- 1 central strike plate
- 2 top and bottom strike plates
- Reversible
- Yellow galvanised
- Central, top and bottom strike plates with rectangular cut-outs
- Packaging: units of 10
- Dimensions : Central 175 x 20 x 2.5 mm (width including lip 32) top and bottom 175 x 20 x 2.5 mm

Ref. 100 OBLONG K

- Square corners
- 1 central strike plate
- 2 top and bottom strike plates
- Reversible
- Yellow galvanised
- Central, top and bottom strike plates with rectangular cut-outs
- Packaging: units of 10
- Dimensions : Central 175 x 20 x 2.5 mm (width including lip 32) top and bottom 175 x 20 x 2.5 mm

Set of reinforced angle strike plates

Ref. 102 R

- Rounded corners
- 1 central strike plate
- 2 top and bottom strike plates
- Non-reversible (please specify right or left hand)
- Yellow galvanised
- Central, top and bottom strike plates with rectangular cut-outs
- Packaging: units of 10
- Dimensions : Central 170 x 20 x 20 x 4 x 2 mm top and bottom 170 x 20 x 20 x 4 x 2 mm

Ref. 102 K

- Square corners
- 1 central strike plate
- 2 top and bottom strike plates
- Non-reversible (please specify right or left hand)
- Yellow galvanised
- Central, top and bottom strike plates with rectangular cut-outs
- Packaging: units of 10
- Dimensions : Central 170 x 20 x 20 x 4 x 2 mm top and bottom 170 x 20 x 20 x 4 x 2 mm

Strike plates for 5700 A2P*

Set of flat reinforced strike plates

Ref. 103 OBLONG R

- Rounded corners
- 1 central strike plate
- 2 top and bottom strike plates
- Reversible
- Yellow galvanised
- Central strike plate with rectangular cut-outs
- Top and bottom strike plate with round cut-outs set 20 mm apart
- Packaging: units of 10
- Dimensions : Central 175 x 20 x 5 mm (width including lip 32) top and bottom 175 x 20 x 5 mm



Strike plates for 5900 A2P*

Set of flat strike plates

Ref. 104 OBLONG R

- Rounded corners
- 1 central strike plate
- 2 top and bottom strike plates
- Reversible
- Yellow galvanised
- Central strike plate with rectangular cut-outs
- Top and bottom strike plates
- Packaging: units of 10

Dimensions : Central 175 x 20 x 2.5 mm (width including lip 32) top and bottom 175 x 20 x 2.5 mm

Ref. 104 OBLONG K

- Square corners
- 1 central strike plate
- 2 top and bottom strike plates
- Reversible
- Yellow galvanised
- Central strike plate with rectangular cut-out
- Top and bottom strike plates
- Packaging: units of 10

Dimensions : Central 175 x 20 x 2.5 mm (width including lip 32) top and bottom 175 x 20 x 2.5 mm

Accessories and supplements for 5000 A2P*

Optional door retainer [please specify when ordering the lock]

Ref. ENT

- For models 5000, 5700 and 5900
- Add ENT before the commercial lock reference
- Without strike plate

Strike plate for door retainer

Ref. G ENT 5

- For rebated doors
- Square corners (K) for metal door frames in white galvanised finish, or rounded corners (R) for timber door frames in yellow galvanised finish (to be specified when ordering)
- Non-reversible (right hand or left hand to be specified when ordering)
- Packaging: units of 10

Dimensions : 230 x 25 x 15 mm

Ref. G cd ENT 5

- For flush doors
- Reversible
- Yellow galvanised for timber door frames or white galvanised for metal door frames
- Packaging: units of 10

Dimensions : 138 x 30 x 15 mm



Standard lock version



Security lock, 50 mm backset, 3 lateral dead bolts

Ref. 5000 T170

Frontplate 1700 x 18 mm, painted, with rounded corners, without strike plate, without cylinder (to be ordered separately)

Packaging: units of 10

Ref. 5000 T204

Frontplate 2040 x 18 mm, painted, with square corners, without strike plate, without cylinder (to be ordered separately)

Packaging: units of 10

Ref. 5000 T225

Frontplate 2250 x 18 mm, painted, with square corners, without strike plate, without cylinder (to be ordered separately)

Packaging: units of 10

Ref. 5900 T204

Frontplate 2040 x 18 mm, painted, with square corners, without strike plate, without cylinder (to be ordered separately), 1 rectangular central dead bolt, 4 freely rotating, anti-saw rounded dead bolts set 100 mm apart

Packaging: units of 10

Ref. 5900 T225

Frontplate 2250 x 18 mm, painted, with square corners, without strike plate, without cylinder (to be ordered separately), 1 rectangular central dead bolt, 4 freely rotating, anti-saw rounded dead bolts set 100 mm apart

Packaging: units of 10

Security lock, 50 mm backset, 5 lateral dead bolts

Ref. 5700 T204

Frontplate 2040 x 18 mm, painted, with square corners, without strike plate, without cylinder (to be ordered separately), 1 rectangular central dead bolt, 4 freely rotating, anti-saw rounded dead bolts set 20 mm apart

Packaging: units of 10

Ref. 5900 T170

Frontplate 1700 x 18 mm, painted, with square corners, without strike plate, without cylinder (to be ordered separately), 1 rectangular central dead bolt, 4 freely rotating, anti-saw rounded dead bolts set 100 mm apart

Packaging: units of 10



Strike plates for standard lock version 5000



100 OBLONG R

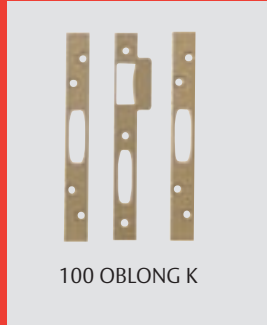

100 OBLONG K

Set of flat strike plates

Ref. 100 OBLONG R

- Rounded corners
- 1 central strike plate
- 2 top and bottom strike plates
- Reversible
- Yellow galvanised
- Central, top and bottom strike plates with rectangular cut-outs
- Packaging: units of 10

Dimensions :

Central 175 x 20 x 2.5 mm (width including lip 32) top and bottom 175 x 20 x 2.5 mm

Ref. 100 OBLONG K

- Square corners
- 1 central strike plate
- 2 top and bottom strike plates
- Reversible
- Yellow galvanised
- Central, top and bottom strike plates with rectangular cut-outs
- Packaging: units of 10

Dimensions :

Central 175 x 20 x 2.5 mm (width including lip 32) top and bottom 175 x 20 x 2.5 mm

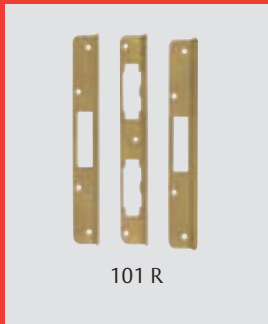

101 R

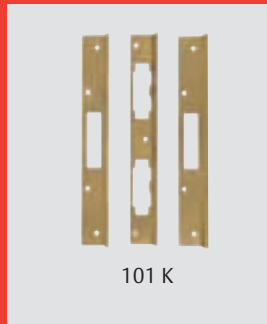

101 K

Set of angle strikes [not NF kite marked]

Ref. 101 R

- Rounded corners
- 1 central strike plate
- 2 top and bottom strike plates
- Reversible
- Yellow galvanised
- Central, top and bottom strike plates with rectangular cut-outs
- Packaging: units of 10

Dimensions : Central

170 x 20 x 20 x 4 x 2 mm, top and bottom

170 x 20 x 20 x 4 x 2 mm

Ref. 101 K

- Square corners
- 1 central strike plate
- 2 top and bottom strike plates
- Reversible
- Yellow galvanised
- Central, top and bottom strike plates with rectangular cut-outs
- Packaging: units of 10

Dimensions : Central

170 x 20 x 20 x 4 x 2 mm, top and bottom

170 x 20 x 20 x 4 x 2 mm



103 OBLONG R

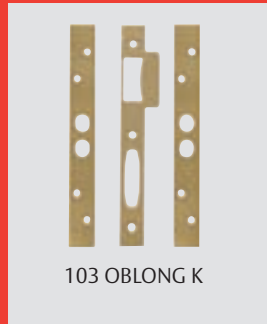

103 OBLONG K

Strike plates for standard lock version 5700

Set of flat strike plates

Ref. 103 OBLONG R

- Rounded corners
- 1 central strike plate
- 2 top and bottom strike plates
- Reversible
- Yellow galvanised
- Central strike plate with rectangular cut-outs
- Top and bottom strike plates with round cut-outs set 20 mm apart
- Packaging: units of 10

Dimensions : Central

175 x 20 x 2.5 mm

(width including lip 32) top and bottom

175 x 20 x 2.5 mm

Ref. 103 OBLONG K

- Square corners
- 1 central strike plate
- 2 top and bottom strike plates
- Reversible
- Yellow galvanised
- Central strike plate with rectangular cut-outs
- Top and bottom strike plates with round cut-outs set 20 mm apart
- Packaging: units of 10

Dimensions : Central

175 x 20 x 2.5 mm

(width including lip 32) top and bottom

175 x 20 x 2.5 mm

Set of angle strikes [not NF kite marked]

Ref. 101 R

- Rounded corners
- 1 central strike plate
- 2 top and bottom strike plates
- Reversible
- Yellow galvanised
- Central, top and bottom strike plates with rectangular cut-outs
- Packaging: units of 10

Dimensions : Central

170 x 20 x 20 x 4 x 2 mm, top and bottom

170 x 20 x 20 x 4 x 2 mm

Ref. 101 K

- Square corners
- 1 central strike plate
- 2 top and bottom strike plates
- Reversible
- Yellow galvanised
- Central, top and bottom strike plates with rectangular cut-outs
- Packaging: units of 10

Dimensions : Central

170 x 20 x 20 x 4 x 2 mm,

top and bottom

170 x 20 x 20 x 4 x 2 mm

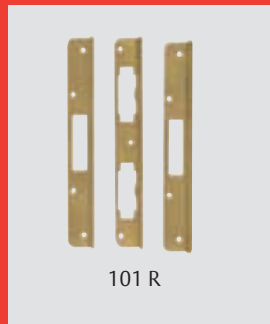

101 R

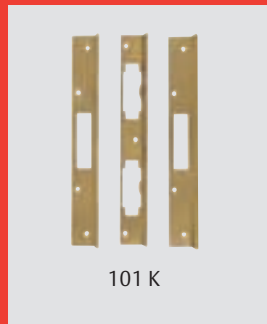

101 K

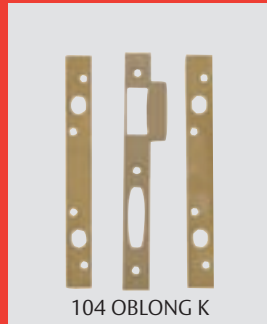
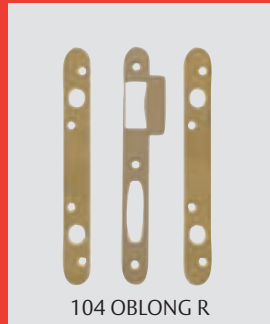

Strike plates for standard lock version 5900

Set of flat strike plates

Ref. 104 OBLONG R

- Rounded corners
- 1 central strike plate
- 2 top and bottom strike plates
- Reversible
- Yellow galvanized
- Central strike plate with rectangular cut-outs
- Top and bottom strike plates with round cut-outs set 100 mm apart
- Packaging: units of 10

Dimensions : Central

175 x 20 x 2.5 mm

(width including lip 32) top and bottom

175 x 20 x 2.5 mm

Ref. 104 OBLONG K

- Square corners
- 1 central strike plate
- 2 top and bottom strike plates
- Reversible
- Yellow galvanized
- Central strike plate with rectangular cut-outs
- Top and bottom strike plates with round cut-outs set 100 mm apart
- Packaging: units of 10

Dimensions : Central

175 x 20 x 2.5 mm

(width including lip 32) top and bottom

175 x 20 x 2.5 mm

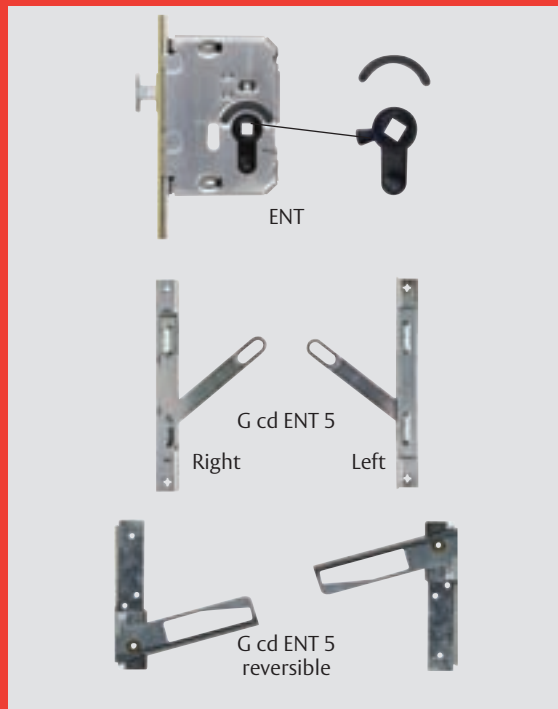

Accessories and supplements for standard lock version 5000

Optional door retainer [please specify when ordering the lock]

Ref. ENT

For models 5000, 5700, 5900 and 5500

Add ENT before the commercial lock reference

Without strike plate

Strike plate for door retainer

Ref. G ENT 5

- For rebated doors

- Square corners (K) for metal door frames in white galvanized finish, or rounded corners (R) for timber door frames in yellow galvanized finish (to be specified when ordering)

- Non-reversible (right hand or left hand to specified when ordering)

- Packaging: units of 10

Dimensions : 230 x 25 x 15 mm

Ref. G cd ENT 5

- For flush doors

- Reversible

- Yellow galvanized for timber door frames or white galvanized for metal door frames

- Packaging: units of 10

Dimensions : 138 x 30 x 15 mm

A large rectangular area with a grey border, containing 20 horizontal dotted lines for writing notes.

ASSA ABLOY is the global leader in door opening solutions, dedicated to satisfying end-user needs for security, safety and convenience.

www.assaabloy.com

